



0728 Internal precision bore gauges for large and deep bores



Model

- 2 point comparator measuring instrument with split probe + measuring pin
- Centering plate
- Mounting hole Ø 8 mm
- Ideal in conjunction with dial gauges or dial comparator gauges

Delivery

- Wooden case
- Without dial gauge

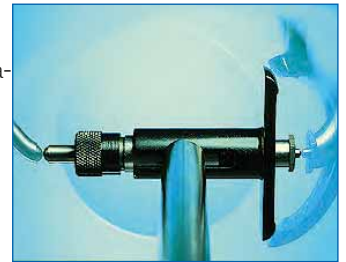

Measuring range	Repeatability	Measuring depth	Measuring pins	Measuring discs	Order no.	List price
mm	µm	mm	pcs	pcs		EUR
Fixed measuring pins, hardened special steel, interchangeable contact pins are carbide tipped						
18 - 35	0.5	110	9	2	0728 105	415.00
35 - 60	0.5	138	7	2	0728 106	403.00
50 - 100	0.5	177	11	3	0728 107	461.00
100 - 160	0.5	234	7	4	0728 108	643.00
160 - 290	0.5	234	7	4	0728 109	927.00
280 - 510	1.5	400	7	4	0728 110	2188.00
Fixed measuring pins and interchangeable contact pins, both pins are carbide tipped						
4.5 - 6	0.5	80	9		0728 201	1057.00
6 - 8	0.5	100	7		0728 202	756.00
8 - 12	0.5	100	9		0728 203	705.00
12 - 20	0.5	110	9	1	0728 204	489.00
18 - 35	0.5	110	9	2	0728 205	495.00
35 - 60	0.5	138	7	2	0728 206	471.00
50 - 100	0.5	177	11	3	0728 207	551.00
100 - 160	0.5	234	7	4	0728 208	717.00
160 - 290	0.5	234	7	4	0728 209	949.00
280 - 510	1.5	400	7	4	0728 210	2240.00

0728 Setting device for internal precision bore gauges



Model

- Setting device for accurate adjustment of internal precision bore gauges to the required nominal dimension, with gauge blocks
- The setting jaws are made of carbide and are lapped to gauge block quality
- Setting device can be used in both, the vertical and horizontal measuring axis

Delivery

- Wooden case
- Incl. stand (excludes gauge blocks)

For measuring range	Error limit	Order no.	List price
mm	µm		EUR
4.5 - 160	2	0728 910	1307.00
18 - 290	2	0728 915	1296.00
160 - 510	2	0728 920	1875.00



0735 Crankshaft gauges



Model

- With dial gauge
- To be positioned between 2 crank arms
- Centre punch is not required
- Horizontal position of the dial gauge is assured with a plumb bob

Delivery

- Wooden case



Measuring range mm	Reading mm	Order no.	List price EUR
45 - 150	0.01	0735 101	408.00
60 - 300	0.01	0735 102	368.00
60 - 500	0.01	0735 103	427.00

0735 Replacement gauge for 0735



Model

- Without backplate

Order no.	List price EUR
For measuring range 45 - 150 mm	
0735 901	225.00
For measuring range 60 - 300 / 60 - 500 mm	
0735 902	187.00



0739 Universal comparator gauge



3

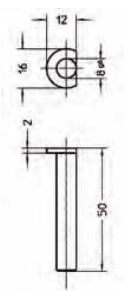

0739 124

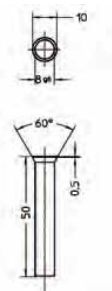

0739 126

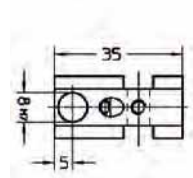

0739 164

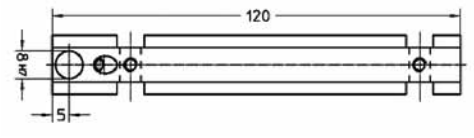

0739 165

Model

- To determine internal and external diameters of recesses, grooves and undercuts in comparison measurement
- Measurement procedure: The part to be measured is determined at the point of reversal between a fixed and moveable measuring insert
- Select either an analogue or digital indicator to show your measuring results
- Sturdy construction
- Simple to set up and easy to operate
- Large range of application
- Ideal for serial measurements
- Optional: Special supporting table is interchangeable

- Repeatability: 2 µm
- Mounting hole for a dial gauge: Ø 8 mm

Delivery

- Without digital indicator (optional)
- Incl. pair of measuring inserts 0739 126 and 0739 124
- Incl. holder for measuring inserts 0739 164 and 0739 165
- In a practical aluminium case

	Measuring range		Base dimensions	Order no.	List price
	external mm	internal mm	mm		EUR
	0 - 180	21 - 200	150 x 150 x 68	0739 102	1780.00



0739 Measuring probes

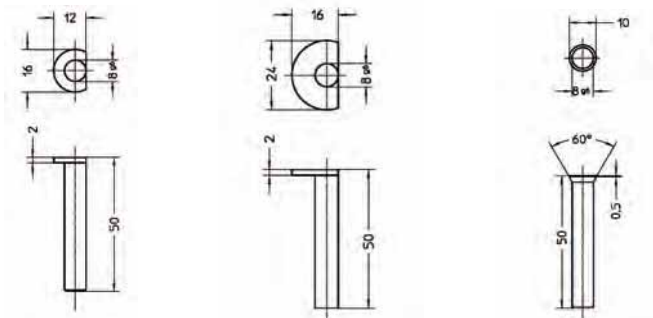

0739 124

0739 125

0739 126

⊗	Description	Order no.	List price EUR
	Probe pair	0739 124	107.00
	Probe pair	0739 125	111.00
	Probe pair	0739 126	64.00
	Pair of probe holder	0739 127*	102.00
	Pair of probe holder	0739 128*	64.00
	Pair of probe holder	0739 129*	123.00
	Probe pair	0739 130	103.00
	Small probe pair	0739 131**	111.00
	Holder pair for 0739131	0739 132	148.00

* For further information regarding probes order no. 0739 127 to 0739 129 see order no. 0710 starting on page 137

** Required holder order no. 0739 132

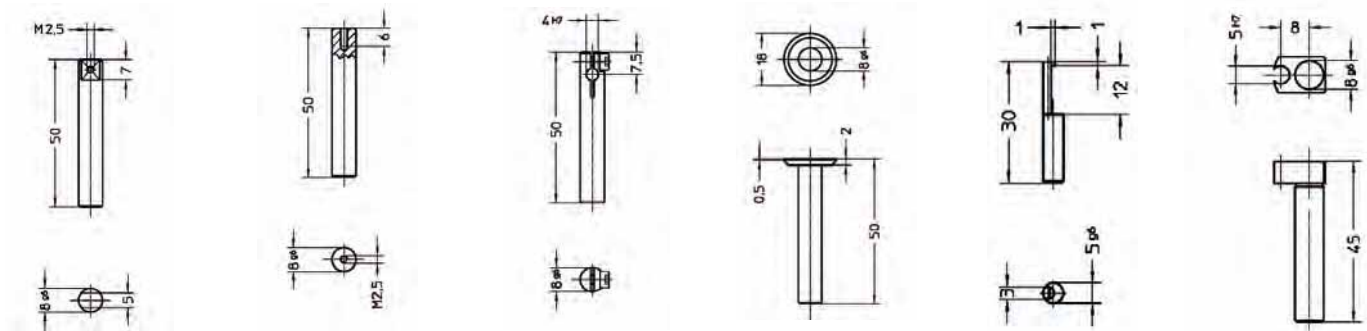

0739 127

0739 128

0739 129

0739 130

0739 131

0739 132

Application examples:

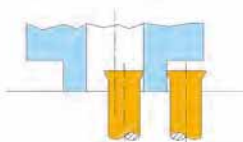

0739 126

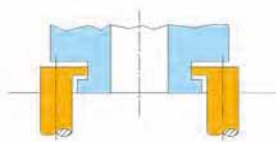

0739 124

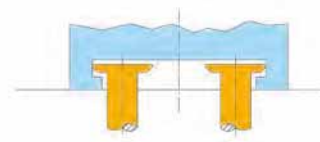

0739 130

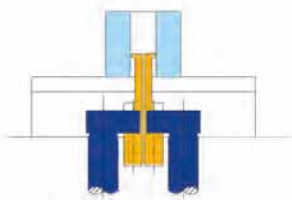

0739 131

0739 132

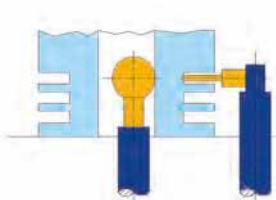

0739 127*

0739 128*

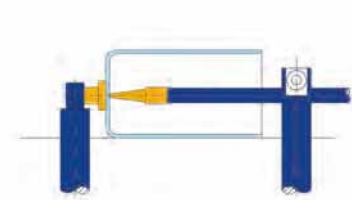

0739 129*

0739 129*



0739 Holder for measuring inserts short / long

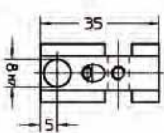

0739 164

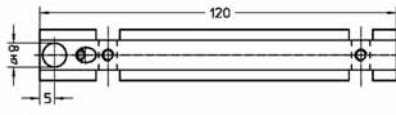

0739 165

Description	Length mm	Order no.	List price EUR
Holder, short	35	0739 164	38.60
Holder, long	120	0739 165	47.60

0739 Large supporting table

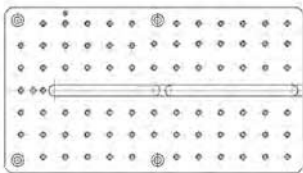

Model

- Made of special steel with wear resistant surface coating
- Equipped with thread bore M5 in grid to attach stop elements
- Internal measurement: 21 - 220 mm
- External measurement: 0 - 300 mm

Delivery

- With leg support to screw

Size of table mm	Order no.	List price EUR
269 x 149	0739 170	279.00

0739 Stop pieces in pairs

Description	Length mm	Width mm	Diameter mm	Dimensions h mm	Order no.	List price EUR
Stop cuboid	60	16		16	0739 121	91.00
Stop disc			24	16	0739 122	103.00
Stop stepped cuboid	60	25		16	0739 123	94.00

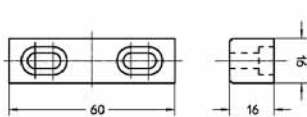

0739 121

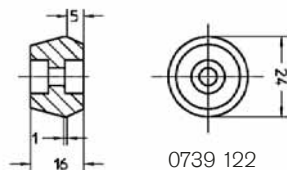

0739 122

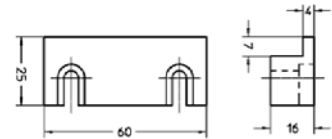

0739 123

Application examples:

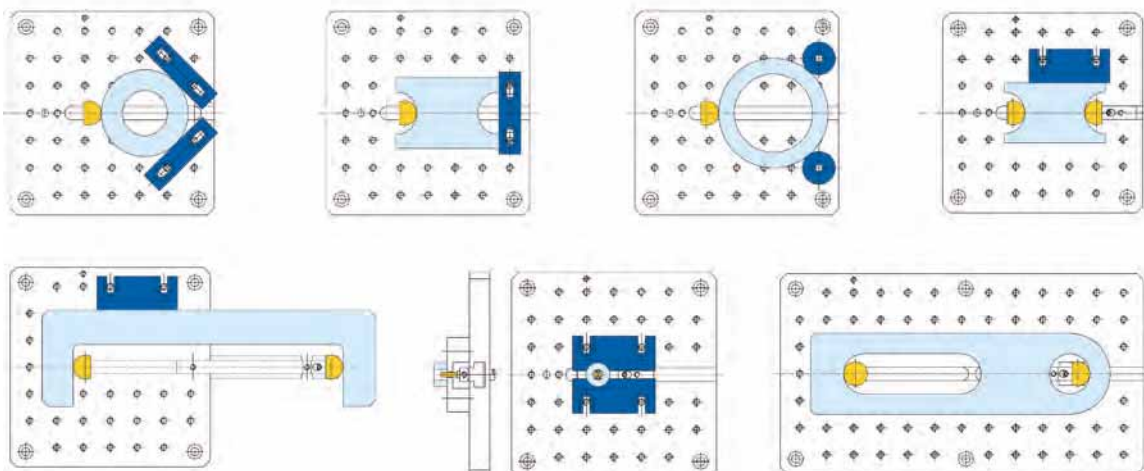



0741 Universal comparator gauge UHRTAST





0741 Comparator gauge UHRTAST



Model

- Comparator gauge for **external and internal measurements** for checking workpieces and setting of machines
- Versatile in use due to wide range of probes and inserts
- Measuring range up to 2000 mm by using optional extensions
- Without indicator
- The direction of the measuring force can be switched, the gauge can be used for external and internal measurements
- The adjustment can be conducted with a setting gauge, a combination of gauge blocks, setting ring or a micrometer
- The measuring range of the moveable measuring arm is 18 mm

Delivery

- Wooden case
- Basic instrument without digital indicator, measuring arms and measuring probes (optional)



Product video

	Measuring range		Measuring forces N	Order no.	List price EUR
	external mm	internal mm			
	5 - 220	15 - 230	external: ~6 N internal: ~4 N	0741 101	1862.00

0741 Pair of probe mounting block

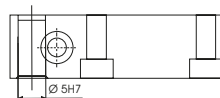

	Order no.	List price EUR
	0741 170	171.00

0741 Extensions



Model

- Combinable with the basic instrument and further extensions by sticking together the pipe construction



0741 112



0741 114

	Length mm	Order no.	List price EUR
	100	0741 112	259.00
	200	0741 114	275.00
	500	0741 116	420.00